

CATALOGO

MISURARE CON GLI ULTRASUONI

Catalogue

Measuring with Ultrasonic



Sensori industriali e barriere per il rilevamento ad ultrasuoni di posizione, distanza e livello
Ultrasonic position-, level-, distance sensors and Barriers

Pionieri nella tecnologia dei sensori ad ultrasuoni

PiL Sensoren GmbH è riconosciuto a livello internazionale come un pioniere e specialista nella tecnologia dei sensori ad ultrasuoni. Da più di 25 anni sviluppa e produce soluzioni di sensori standard e personalizzati per applicazioni industriali, consegnate in tutto il mondo anche come versioni OEM.

I clienti dell'automazione industriale, del monitoraggio e dell'ingegneria automobilistica si affidano proprio a questa esperienza. Un gran numero di sensori speciali sviluppati in collaborazione con i clienti e la gamma di prodotti in costante crescita sottolineano il potere innovativo dell'azienda.

I sensori di prossimità ad ultrasuoni sono una tecnologia indispensabile per l'industria manifatturiera: snellendo i processi di produzione offrono alle aziende un vantaggio competitivo. PiL Sensoren è certificata secondo lo standard di qualità ISO 9001-2015.

Misurare con gli ultrasuoni

I sensori sviluppati dalla PiL si basano sulla misurazione del tempo trascorso dagli ultrasuoni per raggiungere gli oggetti e ritornare, determinandone la posizione e la distanza. Anche i sensori di prossimità capacitivi e le fotocellule sono in grado di rilevare oggetti entro una distanza fissata, però queste misurazioni dipendono dalla struttura della superficie, dal colore e dal materiale dell'oggetto. I sensori ad ultrasuoni della PiL sono stati sviluppati per superare questi limiti nelle applicazioni.

Tutti gli oggetti, anche trasparenti, tutti i materiali solidi o liquidi e le polveri possono essere rilevati. La distanza massima di rilevamento dipende dalle caratteristiche di riflessione dell'oggetto: dimensioni, materiale, struttura della superficie ed orientamento rispetto all'asse del fascio di ultrasuoni. Possono essere rilevati anche fili di diametro 0.2 mm.

L'angolo di apertura dei raggi sonori della PiL è di 8°, caratteristica che ne esalta la precisione.

Affidabili e robusti anche in ambienti difficili.

L'umidità, la polvere e il fumo non causano effetti sulla precisione della misurazione. I sensori sono stati progettati per l'utilizzo in aria atmosferica. L'impiego in altri gas, come per esempio il monossido di carbonio può portare ad errori nella misurazione a causa della diversa velocità ed assorbimento del suono. Anche i liquidi che emettono vapori (come i solventi) possono influenzare il funzionamento dei sensori. La velocità del vento fino ad alcuni m/s può essere gestita senza impedire il buon funzionamento anche all'aria aperta.

I sensori PiL lavorano con una compensazione della temperatura per bilanciare qualsiasi cambiamento della velocità del suono dovuto alle variazioni della temperatura.

Indicazioni sul montaggio

I sensori ad ultrasuoni possono essere montati in qualsiasi posizione evitando possibili depositi sulla parte attiva.

Pioneer in ultrasonic sensor technology

PiL Sensoren GmbH is a pioneer and internationally recognized specialist in ultrasonic sensor technology based in Erlensee near Frankfurt / Main.

For more than 25 years, we have been developing and producing standard and customized sensor solutions for industrial applications which are also delivered worldwide as OEM versions. Customers from the industrial automation, monitoring and automotive engineering trust our expertise.

A large number of special sensors developed in cooperation with our customers, and the permanently growing product range underline the innovative power of the company.

Ultrasonic proximity sensors are an indispensable technology for the manufacturing industry and give companies a competitive advantage by streamlining processes. PiL Sensoren is certified according to the quality standard ISO 9001-2015.

Measuring with ultrasound

PiL sensors are operating on the base on time-of-flight measurement of ultrasonic pulses. They are used to determine the positions and distances of objects in automatic processes. Simple proximity switches, capacitive and photoelectric sensor are capable to detect objects within fixed distances. However, these measurements are depending on surface structure, colour and material of the objects. The ultrasonic sensors of PiL have been developed to overcome such limitations.

Whether solids, bulk solids or liquids: Almost all materials and objects can be detected by ultrasonic sensors. Usually doesn't matter which shape and color the objects have. In particular, hard materials and thin-walled or transparent films are predestined for measurement with ultrasonic sensors. Even very small objects, such as wires with a diameter of 0.2 mm, are reliably detected. PiL also provides suitable solutions for soe-absorbing materials such as cotton wool or foam rubber as well as for objects with coarse-textured surfaces.

Reliable and robust even in harsh environments

Ultrasonic sensors deliver accurate measurement results even in extreme conditions. Humidity, dust and smoke do not affect the measuring accuracy. Also precipitation like rain and snow do not lead to any functional impairment in most cases. Ultrasonic sensors from PiL are designed for use in atmospheric air. Very strong air movements and turbulences can possibly impair a measurement. However, such disturbances can be compensated for by selecting the appropriate sensor.

Standard and customized development

For more than 25 years PiL has been developing and manufacturing ultrasonic sensors of the highest quality. With our comprehensive know-how both in sensor technology and in the various industries we supply, we see ourselves as a strong partner for our customers. One of our main focuses is on the development and production of sensor solutions tailored to customer needs in order to provide the highest flexibility for your product development. We deliver in any desired quantity.

Indice

Applicazioni - Pagina 4

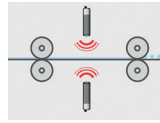

Serie P41 - Pagina 5

Pulsante a bordo per Teach-in. Uscita analogica o con due punti di commutazione. Funzione di sincronizzazione.



Serie P42 - Pagina 6

Sensori singoli e a due parti. Programmando i parametri tramite interfacce standard possono essere adattati a diverse applicazioni.



Serie P43 - Pagina 8

Sensori per misurazioni a brevi distanze. Autoapprendimento da remoto. Uscita analogica o con due punti di commutazione.



Serie P44 - Pagina 10

Sensori con multifunzione. Pulsante per l'autoapprendimento. Uscita analogica o con due punti di commutazione.



Serie P47 - Pagina 10

Uscita analogica con campo fisso di misurazione o un'uscita on-off e regolazione a trimmer. Funzione di sincronizzazione.



Serie P48 - Pagina 12

Sensori a sbarramento di piccole dimensioni. Veloce frequenza di commutazione. Uscita on-off.



Serie P49 - Pagina 12

Sensori economici per largo consumo. Uscita on-off programmabile. Uscita analogica con campo fisso di misurazione.



Serie P53 - Pagina 14

Custodia completamente in acciaio inox. Uscita on-off o analogica e regolabili. Certificazione EHEDG per l'industria alimentare.



Index

Applications - Page 4

Series P41 - Page 5

With teach-In button and one analog or two switching outputs. A hold/sync-function is integrated.

Series P42 - Page 6

One- and two-part sensors. They can be adapted to different tasks by programming the parameters via standardized interfaces.

Series P43 - Page 8

Sensors with short measuring distance. Teach-In via cable with one analog or two switching outputs.

Series P44 - Page 10

Multifunction sensors. With Teach-In button with one analog or two switching outputs.

Series P47 - Page 10

Basic series with fixed analog characteristic or one switching output as well as an hold/sync-function.

Series P48 - Page 12

Very small, fast switching barriers. Quick switch frequency. On-off output.

Series P49 - Page 12

Inexpensive sensors for the price-sensitive market with higher quantities.

Series P53 - Page 14

Fully encapsulated stainless steel housing for the use in harsh or hygienic conditions. EHEDG certification for the food industry.



Tensione del nastro
Web Tension

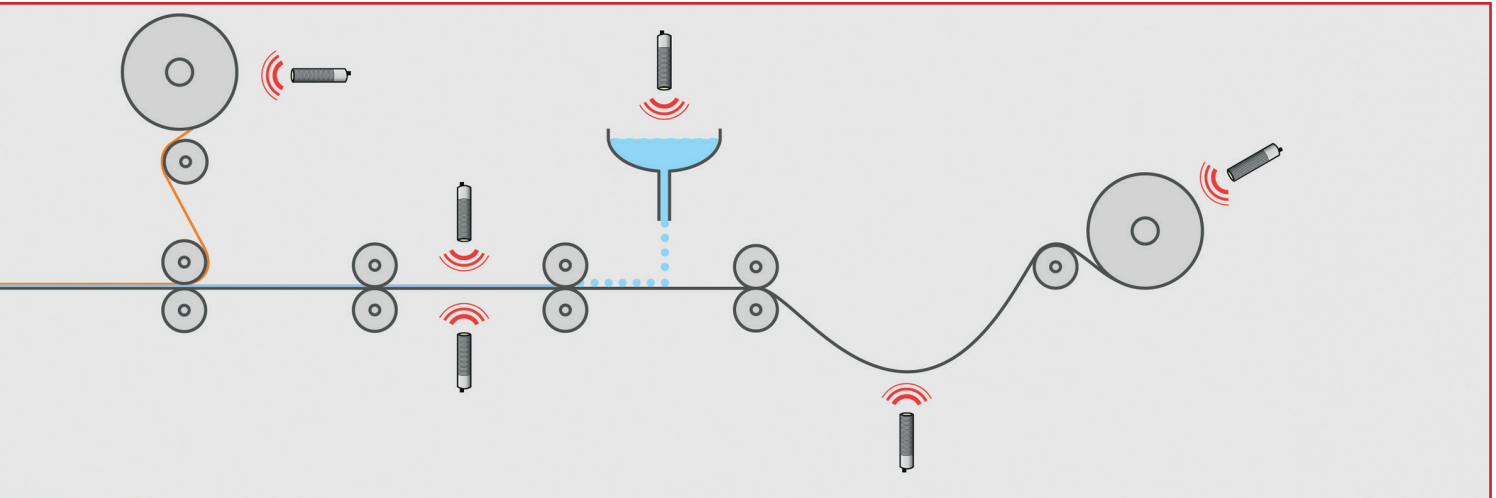

Are di utilizzo

Vasta gamma di applicazioni:

- Misurazione di distanza di parti di macchinari o di prodotti in movimento
- Controllo del livello in taniche (anche di piccole dimensioni)
- Misurazione del livello di prodotti e liquidi
- Rilevamento di oggetti in movimento di qualsiasi materiale, anche vetro o materiali trasparenti
- Rilevamento di presenza di oggetti e persone
- Conteggio di oggetti di diverse dimensioni
- Controllo di avvolgimento e svolgimento di bobine nell'industria tessile, cartaria e delle lamine
- Regolazione della tensione dei materiali nei processi produttivi (controllo d'ansa)
- Protezione alle collisioni in caso di veicoli per trasporto ad autocontrollo. (AGV's)

Operation areas

Wide range of possible applications:

- Distance measurement of moving machine parts
- Detection of moving objects made of all materials, also glass
- Presence detection of objects and humans
- Counting of objects with various shapes
- Completeness control of objects in beles (bottles in a box)
- Level measurement of bulk goods storage and liquids in silos and containers
- Winding and unwinding control of rolls in the paper-, coils- textile industries
- Web tension control in a multi-level working process
- Sorting control by measuring the height profile of packaging items on
- Position control by measuring the stacking height and overlaps on loaders
- Area Monitoring
- Collision avoidance in the case of automated guided vehicles (AGV's)

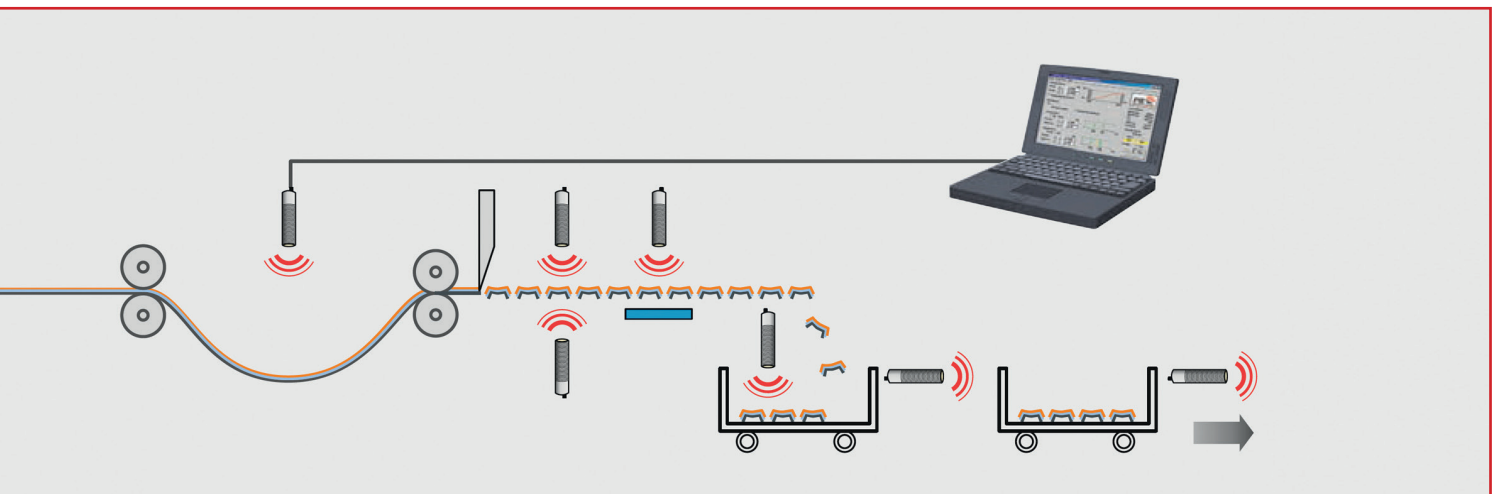

Serie P41

Con questa serie sia le uscite analogiche che a commutazione vengono programmate mediante apprendimento. Questo avviene tramite un pulsante seguendo una procedura facile e breve. La serie P41 ha sensori con uscita analogica 0 .. 10V o 0.. 20mA oppure con due uscite a commutazione (2xPNP o 2xNPN). E' integrata la funzione di sincronizzazione qualora fosse necessaria.



Series P41

In this series the analogue and the switching outputs are programmed by teach-in. This is done in a very simple and very accurate way via a teach-in using a built-in pushbutton. This series has an analogue 0 .. 10V or 4 .. 20mA output or two switching outputs. A hold/sync-function is integrated.

P41						
Serie Series	P41-40-xx-CM12	P41-50-xx-CM12	P41-80-xx-CM12	P41-160-xx-CM12	P41-200-xx-CM12	P41-350-xx-CM12
Distanza di rilevamento Sensing distance	40- 400 mm	60- 500 mm	100- 800 mm	80- 1600 mm	200- 2000 mm	350- 3500 mm
Dimensioni custodia Housing dimensions	41 * 101 mm	40 * 101 mm	39 * 101 mm	38 * 101 mm	37 * 101 mm	36 * 101 mm
Materiale custodia Housing material	PBT					
Connessione Connection	Connettore Binder M12x5p Binder connector M12x5p					
Caratteristiche aggiuntive Additional Features	Pulsante per l'apprendimento, Funzione di sincronizzazione Teach-in pushbutton, Hold/Sync					
Tipo (articolo n.) Types (article no.)						
Uscita PNP Switch Output PNP	P41-40-2P-CM12 (514842)	P41-50-2P-CM12 (514822)	P41-80-2P-CM12 (514820)	P41-160-2P-CM12 (515638)	P41-200-2P-CM12 (514774)	P41-350-2P-CM12 (514818)
Uscita NPN Switch Output NPN	P41-40-2N-CM12 (514844)	P41-50-2N-CM12 (514828)	P41-80-2N-CM12 (514826)	P41-160-2N-CM12 (515418)	P41-200-2N-CM12 (514782)	P41-350-2N-CM12 (514823)
Uscita 0...10V Output 0...10V	P41-40-U-CM12 (514846)	P41-50-U-CM12 (514834)	P41-80-U-CM12 (514832)	P41-160-U-CM12 (515430)	P41-200-U-CM12 (514778)	P41-350-U-CM12 (514830)
Uscita 0...4mA Output 4...20mA	P41-40-I-CM12 (514848)	P41-50-I-CM12 (514840)	P41-80-I-CM12 (514838)	P41-160-I-CM12 (515625)	P41-200-I-CM12 (514778)	P41-350-I-CM12 (514836)

Serie P42

Tutti i sensori della serie P42 hanno l'uscita analogica 0..10V/4...20mA e due uscite in commutazione. Esse vengono programmate tramite interfaccia RS232 o RS485. La curva caratteristica, la zona cieca, i punti di commutazione, la sensibilità, i filtri elettronici, i tempi di risposta e gli indirizzi del sensore sono ottimizzati per l'applicazione. Per la comunicazione con il computer non è necessario un adattatore speciale perchè l'accesso è diretto all'interfaccia del sensore.

Series P42

All sensors of the P42 series have one analog output and two switching outputs. They are programmed via an interface RS232 or RS485. Characteristic curve, blind zone, switching points, sensitivity, electronic filters, response time and sensor addresses are optimally adapted to the measuring task. For the communication with the computer, no special adapter is required, it can be accessed directly to the interface on the sensor.

P42	Tipo (articolo n.) Type (article no.)	Distanza di rilevamento Sensing Distance	Uscita Output	Interfaccia Interface	Connessione Connection	Regolazione Adjustment Setpoint	Custodia Housing	
	P42-350-M30-PBT-UI2P-RS232-C723 (516334)	350- 3500 mm	0 .. 10V + 4 .. 20mA 2xPNP NO/NC	RS232	Connettore Binder Serie 723 Binder connector Series 723	Programmabile Programmable	M30, PBT	
	P42-350-M30-PBT-U2P-RS485-C723 (513695)		0 .. 10V 2xPNP NO/NC	RS485				
	P42-350-M30-PBT-I2P-RS485-C723 (516538)		4 .. 20mA 2xPNP NO/NC	RS485				
	P42-300-M30-ST-U2P-RS232-C723 (512205)	300- 3000 mm	0 .. 10V 2xPNP NO/NC	RS232			M30, Acciaio inox Stainless steel	
	P42-300-M30-ST-U2P-RS485-C723 (512213)			RS485				
	P42-300-M30-ST-I2P-RS232-C723 (512209)		4 .. 20mA 2xPNP NO/NC	RS232				
	P42-300-M30-ST-I2P-RS485-C724 (512216)			RS485				
	P42-200-M30-PBT-UI2P-RS232-C723 (515568)	250- 2000 mm	0 .. 10V + 4 .. 20mA 2xPNP NO/NC	RS232			M30, PBT	
	P42-200-M30-ST-U2P-RS232-C723 (512206)						M30, Acciaio inox Stainless steel	
	P42-200-M30-ST-I2P-RS232-C723 (512210)							4 .. 20mA 2xPNP NO/NC
	P42-150-M30-PBT-U2P-RS232-C723 (513574)	150- 1500 mm	0 .. 10V 2xPNP NO/NC	RS232			M30, PBT	
	P42-150-M30-PBT-U2P-RS485-C723 (513775)			RS485				
	P42-150-M30-PBT-I2P-RS232-C723 (512279)		4 .. 20mA 2xPNP NO/NC	RS232				
	P42-150-M30-PBT-I2P-RS485-C723 (513776)			RS485				
	P42-150-M30-ST-U2P-RS232-C723 (512207)		0 .. 10V 2xPNP NO/NC	RS232			M30, Acciaio inox Stainless steel	
	P42-150-M30-ST-U2P-RS485-C723 (512214)							RS485
	P42-150-M30-ST-I2P-RS232-C723 (512211)			4 .. 20mA 2xPNP NO/NC				RS232
	P42-150-M30-ST-I2P-RS485-C723 (512217)							RS485
	P42-60-M30-ST-U2P-RS232-C723 (512208)		100- 600 mm	0 .. 10V 2xPNP NO/NC			RS232	M30, Acciaio inox Stainless steel
	P42-60-M30-ST-I2P-RS232-C723 (512212)							

Testa sensibile (necessaria elettronica di valutazione) Sensorheads (evaluation electronic is needed)				
P42				
Tipo (articolo n.) Type (article no.)	P42-90-M30-ST-C723 (512203)	P42-150-M30-ST-C723 (513657)	P42-250-M30-ST-C723 (512199)	P42-400-M30-ST-C723 (512196)
Distanza di rilevamento Sensing distance	100 .. 900 mm	150 .. 1500 mm	250 .. 2500 mm	400 .. 4000 mm
Uscita Output	Unità di valutazione esterna External signal measurement			
Connessione Connection	Connettore Binder Serie 723 Binder connector Series 723			

Unità di valutazione esterna per testa sensibile External evaluation electronics for sensorheads				
P42				
Tipo (articolo n.) Type (article no.)	P42-90-BOX-UI2P-RS232 (512254)	P42-150-BOX-UI2P-RS232 (513923)	P42-250-BOX-UI2P-RS232 (512252)	P42-400-BOX-UI2P-RS232 (512250)
Distanza di rilevamento Sensing distance	100 .. 900 mm	150 .. 1500 mm	250 .. 2500 mm	400 .. 4000 mm
Uscita Output	0 .. 10V + 4 .. 20mA 2xPNP NO/NC			
Interfaccia Interface	RS232			
Connessione Connection	Connettore Binder Serie 723 Connector Binder Series 723			



SET Sensore ad ultrasuoni e unità di valutazione SET Ultrasonic sensor and evaluation unit				
P42				
Tipo (articolo n.) Type (article no.)	P42-90-Set/ M30-UI2P-RS232 (511922)	P42-150-Set/ M30-UI2P-RS232 (512262)	P42-250-Set/ M30-UI2P-RS232 (512261)	P42-400-Set/ M30-UI2P-RS232 (512259)
Distanza di rilevamento Sensing distance	100 .. 900 mm	150 .. 1500 mm	250 .. 2500 mm	400 .. 4000 mm
Uscita Output	0 .. 10V + 4 .. 20mA 2xPNP NO/NC			
Interfaccia Interface	RS232			
Connessione Connection	Connettore Binder Serie 723 Connector Binder Series 723			
Materiale custodia Housing material	M30, Acciaio inox M30, Stainless steel			

Serie P43

Serie High-Performance per applicazioni esigenti. Sensori ON-OFF con due punti di commutazione o analogici tarabili su tutto il campo di misurazione. Programmazione mediante autoapprendimento da remoto. Custodia cilindrica e rettangolare di diverse dimensioni e materiali.

Series P43

For demanding applications with more than one switching point or variable analog characteristic, window and hysteresis function. Teach-in can be accessed remotely by cable teach integrated in supply/control cable. Sensors of this series have one analog 0 .. 10V or 4 .. 20mA or two switching outputs.

P43	Tipo (articolo n.) Type (article no.)		Distanza di rilevamento Sensing Distance	Uscita Output	Connessione Connection		Regolazione Adjustment Setpoint	Custodia Housing
	P43-600-Q50-PBT-2P-CM12	(514722)	600- 6000 mm	2 x PNP, NO/NC	-	Binder M12x5p	Via cavo Cable Teach-in	Q50, PBT
	P43-600-Q50-PBT-2N-CM12	(514855)		2 x NPN, NO/NC				
	P43-600-Q50-PBT-U-CM12	(514850)		0 .. 10V				
	P43-600-Q50-PBT-I-CM12	(514852)		4 .. 20mA				
	P43-350-M30-PBT-2P-CM12	(514664)	300- 3500 mm	2 x PNP, NO/NC	-	Binder M12x5p	Via cavo Cable Teach-in	M30, PBT
	P43-350-M30-PBT-2P-2m	(514607)			2m	-		
	P43-350-M30-PBT-2N-CM12	(514749)		2 x NPN, NO/NC	-	Binder M12x5p		
	P43-350-M30-PBT-2N-2m	(514748)			2m	-		
	P43-350-M30-PBT-U-CM12	(514665)		0 .. 10V	-	Binder M12x5p		
	P43-350-M30-PBT-U-2m	(514680)			2m	-		
	P43-350-M30-PBT-I-CM12	(514578)		4 .. 20mA	-	Binder M12x5p		
	P43-350-M30-PBT-I-2m	(514677)			2m	-		
	P43-200-M18-PBT-2P-CM12	(514705)	200- 2000 mm	2 x PNP, NO/NC	-	Binder M12x5p	Via cavo Cable Teach-in	M18, PBT
	P43-200-M18-PBT-2P-2m	(514658)			2m	-		
	P43-200-M18-PBT-2N-CM12	(514760)		2 x NPN, NO/NC	-	Binder M12x5p		
	P43-200-M18-PBT-2N-2m	(514754)			2m	-		
	P43-200-M18-PBT-U-CM12	(514572)		0 .. 10V	-	Binder M12x5p		
	P43-200-M18-PBT-U-2m	(514661)			2m	-		
	P43-200-M18-PBT-I-CM12	(514714)		4 .. 20mA	-	Binder M12x5p		
	P43-200-M18-PBT-I-2m	(514676)			2m	-		

Misurazione del livello Level measurement



P43	Tipo (articolo n.) Type (article no.)		Distanza di rilevamento Sensing Distance	Uscita Output	Connessione Connection		Regolazione Adjustment Setpoint	Custodia Housing	
	P43-160-M18-PBT-2P-CM12	(515621)	80- 1600 mm	2 x PNP, NO/NC	-	Binder M12x5p	Via cavo Cable Teach-in	M18, PBT	
	P43-160-M18-PBT-2P-2m	(515646)			2m	-			
	P43-160-M18-PBT-2N-CM12	(517059)		2 x NPN, NO/NC	-	Binder M12x5p			
	P43-160-M18-PBT-2N-2m	(515655)			2m	-			
	P43-160-M18-PBT-U-CM12	(515524)		0 .. 10V	-	Binder M12x5p			
	P43-160-M18-PBT-U-2m	(515599)			2m	-			
	P43-160-M18-PBT-I-CM12	(515527)		4 .. 20mA	-	Binder M12x5p			
	P43-160-M18-PBT-I-2m	(515521)			2m	-			
		P43-80-M18-PBT-2P-CM12	(514642)	100- 800 mm	2 x PNP, NO/NC	-	Binder M12x5p	Via cavo Cable Teach-in	M18, PBT
		P43-80-M18-PBT-2P-2m	(514659)			2m	-		
		P43-80-M18-PBT-2N-CM12	(514758)		2 x NPN, NO/NC	-	Binder M12x5p		
		P43-80-M18-PBT-2N-2m	(514755)			2m	-		
		P43-80-M18-PBT-U-CM12	(514614)		0 .. 10V	-	Binder M12x5p		
		P43-80-M18-PBT-U-2m	(514663)			2m	-		
		P43-80-M18-PBT-I-CM12	(514746)		4 .. 20mA	-	Binder M12x5p		
		P43-80-M18-PBT-I-2m	(514675)			2m	-		
		P43-50-M18-PBT-2P-CM12	(514656)	60- 500 mm	2 x PNP, NO/NC	-	Binder M12x5p	Via cavo Cable Teach-in	M18, PBT
		P43-50-M18-PBT-2P-2m	(514660)			2m	-		
P43-50-M18-PBT-2N-CM12		(514762)	2 x NPN, NO/NC		-	Binder M12x5p			
P43-50-M18-PBT-2N-2m		(514756)			2m	-			
P43-50-M18-PBT-U-CM12		(514657)	0 .. 10V		-	Binder M12x5p			
P43-50-M18-PBT-U-2m		(514662)			2m	-			
P43-50-M18-PBT-I-CM12		(514686)	4 .. 20mA		-	Binder M12x5p			
P43-50-M18-PBT-I-2m		(514674)			2m	-			
	P43-40-M18-PBT-2P-CM12	(515307)	30- 400 mm	2 x PNP, NO/NC	-	Binder M12x5p	Via cavo Cable Teach-in	M18, PBT	
	P43-40-M18-PBT-2P-2m	(515382)			2m	-			
	P43-40-M18-PBT-2N-CM12	(515336)		2 x NPN, NO/NC	-	Binder M12x5p			
	P43-40-M18-PBT-2N-2m	(515272)			2m	-			
	P43-40-M18-PBT-U-CM12	(515289)		0 .. 10V	-	Binder M12x5p			
	P43-40-M18-PBT-U-2m	(515292)			2m	-			
	P43-40-M18-PBT-I-CM12	(515318)		4 .. 20mA	-	Binder M12x5p			
	P43-40-M18-PBT-I-2m	(515432)			2m	-			
	P43-25-M12-ST-P-CM12	(514859)	25- 250 mm	1 x PNP, NO/NC	-	Binder M12x4p	Via cavo Cable Teach-in	M12, Acciaio Inox Stainless steel	
	P43-25-M12-ST-N-CM12	(514973)		1 x NPN, NO/NC	-	-			
	P43-25-M12-ST-U-CM12	(517084)		0 .. 10V	-	Binder M12x4p			
	P43-25-R40-PBT-P-CM8	(515153)	25- 250 mm	1 x PNP, NO/NC	-	-	Via cavo Cable Teach-in	R40, PBT	
	P43-25-R40-PBT-N-CM8	(515431)		1 x NPN, NO/NC	-	Binder M8x4p			
	P43-25-R40-PBT-U-CM8	(515208)		0 .. 10V	-	-			

Serie P44

Versione multifunzione con due uscite analogiche e due uscite in commutazione, facilmente impostabili con un pulsante sul sensore.

Series P44

The P44 series has two analogue and two switching outputs. The outputs are set very easily via a sensor button. As analogue output are 0 .. 10V and 4 .. 20mA available. As digital output are the switching points NoOpen and NoClosed available.



P44	Tipo (articolo n.) Type (article no.)	Distanza di rilevamento Sensing Distance	Uscita Output	Connessione Connection	Regolazione Adjustment Setpoint	Custodia Housing	
	P44-350-M30-UI2P-CM12 (515533)	350- 3500 mm	2 x PNP, NO/NC 0 .. 10V + 4 .. 20mA	Connettore M12x5p Connector M12x5p	Pulsante di apprendimento Teach-in Button	M30, PBT	
	P44-350-M30-UI2N-CM12 (515543)		2 x NPN, NO/NC 0 .. 10V + 4 .. 20mA				
	P44-350-M30-2P-CM12 (513853)		2 x PNP, NO/NC				
	P44-200-M30-UI2P-CM12 (515567)	250- 2000 mm	2 x PNP, NO/NC 0 .. 10V + 4 .. 20mA				
	P44-200-M30-UI2N-CM12 (515562)		2 x NPN, NO/NC 0 .. 10V + 4 .. 20mA				
	P44-200-M30-2P-CM12 (512296)		2 x PNP, NO/NC				
	P44-160-M30-UI2P-CM12 (515554)	P44-160-M30-UI2N-CM12 (515555)	80- 1600 mm				2 x PNP, NO/NC 0 .. 10V + 4 .. 20mA
	P44-160-M30-UI2N-CM12 (515555)						2 x NPN, NO/NC 0 .. 10V + 4 .. 20mA
	P44-35-M30-UI2N-CM12 (515586)	60- 350 mm	2 x NPN, NO/NC 0 .. 10V + 4 .. 20mA				

Serie P47

Sensori adatti ad applicazioni standard. Le versioni con uscita ON-OFF hanno il trimmer di regolazione mentre le versioni con uscita analogica hanno un campo fisso di misurazione e funzione di sincronizzazione per montare più sensori vicini.

Series P47

For basic usage, simple adjustment of the switching sensors with potentiometer, analogue sensors with fixed curve. Basic sensors with fixed adjusted analogue curve or one adjustable switching output as well as a hold/sync-function.



P47	Tipo (articolo n.) Type (article no.)	Distanza di rilevamento Sensing Distance	Uscita Output	Connessione Connection	Regolazione Adjustment Setpoint	Custodia Housing	Barriera Barrier
	P47-500-Q50-U-CM12 (514466)	500- 5000 mm	0 .. 10V	Connettore M12x4p Connector M12x4p	Fissa Fixed	Q50, PBT	-
	P47-500-Q50-I-CM12 (514582)		4 .. 20mA				-

P47	Tipo (articolo n.) Type (article no.)	Distanza di rilevamento Sensing Distance	Uscita Output	Connessione Connection	Regolazione Adjustment Setpoint	Custodia Housing	Barriera Barrier			
	P47-250-M30-PNO-CM12 (512361)	300- 2500 mm	1 x PNP, NO	Connettore M12x5p Connector M12x5p	Potenziometro Potentiometer	M30, PBT	-			
	P47-250-M30-PNO-CM12-B (512370)		1 x PNP, NO				si yes			
	P47-250-M30-PNO-2m (512364)		1 x PNP, NO	Cavo 2m / Cable 2 m			Fissa Fixed	-		
	P47-250-M30-NNO-CM12 (515038)		1 x NPN, NO	Connettore M12x5p Connector M12x5p				-		
	P47-250-M30-U-CM12 (512363)		0 .. 10V		-					
	P47-250-M30-U-2m (512366)		0 .. 10V	Cavo 2m / Cable 2 m	-					
	P47-250-M30-I-CM12 (513879)		4 .. 20mA	Connettore M12x5p Connector M12x5p	-					
	P47-250-M30-I-2m (513878)		4 .. 20mA	Cavo 2m / Cable 2 m	-					
	P47-150-M18-PNO-m3CM12-B (512359)	400- 1500 mm	1xPNP, NO	Cavo 0,3m + conn. M12x5p Cable 0,3m + conn. M12x5p	Potenziometro Potentiometer	M18, PBT	si yes			
	P47-150-M18-PNO-2m-B (516686)			Cavo 2m / Cable 2 m						
	P47-150-M18-PNO-m3CM12 (512344)	200- 1500 mm	1 x PNP, NO	Cavo 0,3m + conn. M12x5p Cable 0,3m + conn. M12x5p		Fissa Fixed	M18, PBT	-		
	P47-150-M18-PNO-2m (512348)			Cavo 2m / Cable 2 m						
	P47-150-M18-NNO-m3CM12 (512165)		1 x NPN, NO	Cavo 0,3m + conn. M12x5p Cable 0,3m + conn. M12x5p						
	P47-150-M18-NNO-2m (513576)			Cavo 2m / Cable 2 m						
	P47-150-M18-U-CM12 (512335)	100- 600 mm	0 .. 10V	Connettore M12x5p Connector M12x5p	Potenziometro Potentiometer	M18, PBT	si yes			
	P47-150-M18-U-2m (512352)			Cavo 2m / Cable 2 m						
	P47-150-M18-I-CM12 (513877)		4 .. 20mA	Connettore M12x5p Connector M12x5p		Fissa Fixed	M18, PBT	-		
	P47-150-M18-I-2m (513876)			Cavo 2m / Cable 2 m						
	P47-60-M18-PNO-m3CM12 (512345)	250- 600 mm	1 x PNP, NO	Cavo 0,3m + conn. M12x5p Cable 0,3m + conn. M12x5p	Potenziometro Potentiometer				M18, PBT	-
	P47-60-M18-PNO-2m (512349)			Cavo 2m / Cable 2 m						
	P47-60-M18-PNO-m3CM12-B (512360)	100- 600 mm	1 x PNP, NO	Cavo 0,3m + conn. M12x5p Cable 0,3m + conn. M12x5p	Fissa Fixed	M18, PBT	-			
	P47-60-M18-NNO-2m (514035)			1 x NPN, NO				Cavo 2m / Cable 2 m		
	P47-60-M18-U-CM12 (512336)		0 .. 10V	Connettore M12x5p Connector M12x5p						
	P47-60-M18-U-2m (512353)			Cavo 2m / Cable 2 m						
	P47-60-M18-I-CM12 (513875)	60- 300 mm	4 .. 20mA	Connettore M12x5p Connector M12x5p	Potenziometro Potentiometer	M18, PBT	-			
	P47-60-M18-I-2m (513874)			Cavo 2m / Cable 2 m						
	P47-30-M18-PNO-m3CM12 (514335)	60- 300 mm	1 x PNP, NO	Cavo 0,3m + conn. M12x5p Cable 0,3m + conn. M12x5p		Fissa Fixed		M18, PBT	-	
	P47-30-M18-PNO-2m (514297)			Cavo 2m / Cable 2 m						
P47-30-M18-NNO-m3CM12 (517136)	1 x NPN, NO		Cavo 0,3m + conn. M12x5p Cable 0,3m + conn. M12x5p							
P47-30-M18-NNO-2m (516143)			Cavo 2m / Cable 2 m							
P47-30-M18-U-CM12 (514338)	0 .. 10V	Connettore M12x5p Connector M12x5p	Fissa Fixed	M18, PBT	-					
P47-30-M18-U-2m (514300)		Cavo 2m / Cable 2 m								
P47-30-M18-I-CM12 (514475)	4 .. 20mA	Connettore M12x5p Connector M12x5p								
P47-30-M18-I-2m (514423)		Cavo 2m / Cable 2 m								



Serie P48

Questi sensori a sbarramento hanno emettitore e ricevitore separati, con LED di segnalazione dell'uscita (PNP o NPN).

Series P48

This barriers consist of separate transmitter and receiver with LED as a single way system.



P48	Tipo (articolo n.) Type (article no.)	Distanza di rilevamento Sensing Distance	Uscita Output	Connessione Connection	Regolazione Adjustment Setpoint	Custodia Housing
	P48-110-R50-PNO-2m-B (514130)	fino / up to 1100 mm	1 x PNP, NO	Cavo 2m Cable 2m	-	R50, PBT
	P48-110-R50-NNO-2m-B (514224)		1 x NPN, NO			
	P48-110-R50-PNC-2m-B (515648)		1 x PNP, NC			
	P48-110-R50-NNC-2m-B (516750)		1 x NPN, NC			
	P48-30-R30-PNO-2m-B (513933)	fino / up to 300 mm	1 x PNP, NO	Cavo 2m Cable 2m	-	R30, PBT
	P48-30-R30-NNO-2m-B (514121)		1 x NPN, NO			
	P48-30-R30-PNC-2m-B (514020)		1 x PNP, NC			
	P48-30-R30-NNC-2m-B (514122)		1 x NPN, NC			

Serie P49

Sensori economici per largo impiego. Versioni On-Off programmabili mediante autoapprendimento con filo esterno e i sensori analogici con campo fisso di misurazione.

Series P49

Cost-effective sensors for the price-sensitive market with medium to high quantities.

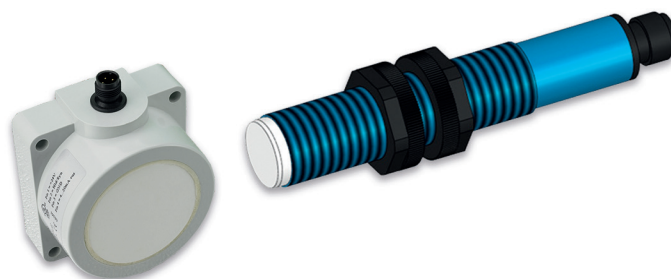

P49	Tipo (articolo n.) Type (article no.)	Distanza di rilevamento Sensing Distance	Uscita Output	Connessione Connection	Regolazione Adjustment Setpoint	Custodia Housing
	P49-600-Q50-PNO-CM12 (516720)	600- 6000 mm	1 x PNP, NO	Connettore M12 x 4 poli Connector M12 x 4 poles	Cavo Teach-In Cable Teach-In	Q50, PBT
	P49-600-Q50-U-CM12 (516702)		0 .. 10V		Fissa Fixed	
	P49-350-M30-PNO-CM12 (516670)	350- 3500 mm	1 PNP, NO	Connettore M12 x 4 poli Connector M12 x 4 poles	Fissa Fixed	M30, PBT
	P49-350-M30-U-CM12 (516700)		0 .. 10V			
	P49-350-M30-I-CM12 (517350)		4 .. 20 mA			
	P49-350-M30-PNO-2m (517279)		1x PNP NO	Cavo 2m Cable 2m	Cavo Teach-In Cable Teach-In	
	P49-350-M30-U-2m (516485)		0 .. 10V		Fissa Fixed	
	P49-350-M30-I-2m (517282)		4 .. 20 mA			

P49	Tipo (articolo n.) Type (article no.)	Distanza di rilevamento Sensing Distance	Uscita Output	Connessione Connection	Regolazione Adjustment Setpoint	Custodia Housing
	P49-200-M18-PNO-CM12 (516474)	200- 2000 mm	1 x PNP, NO	Connettore M12 x 4 poli Connector M12 x 4 poles	Cavo Teach-In Cable Teach-In	M18, PBT
	P49-200-M18-U-CM12 (516692)		0 .. 10V		Fissa Fixed	
	P49-200-M18-I-CM12 (517169)		4 .. 20 mA			
	P49-200-M18-PNO-2m (517270)		Cavo 2m Cable 2m	1x PNP NO	Cavo Teach-In Cable Teach-In	
	P49-200-M18-U-2m (517275)			0 .. 10 V	Fissa Fixed	
	P49-200-M18-I-2m (517283)			4 .. 20 mA		
	P49-160-M18-PNO-CM12 (516721)	80- 1600 mm	1 x PNP, NO	Connettore M12, 4-polig	Cavo Teach-In Cable Teach-In	
	P49-160-M18-U-CM12 (516685)		0 .. 10V		Fissa Fixed	
	P49-160-M18-I-CM12 (517168)		4 .. 20 mA			
	P49-160-M18-PNO-2m (517271)		Cavo 2m Cable 2m	1x PNP NO	Cavo Teach-In Cable Teach-In	
	P49-160-M18-U-2m (516685)			0 .. 10 V	Fissa Fixed	
	P49-160-M18-I-2m (517337)			4 .. 20 mA		
	P49-80-M18-PNO-CM12 (516722)	100- 800 mm	1 x PNP, NO	Connettore M12 x 4 poli Connector M12 x 4 poles	Cavo Teach-In Cable Teach-In	
	P49-80-M18-U-CM12 (516694)		0 .. 10V		Fissa Fixed	
	P49-80-M18-I-CM12 (517507)		4 .. 20 mA			
	P49-80-M18-PNO-2m (517272)		Cavo / Cable 2m	1x PNP NO	Cavo Teach-In Cable Teach-In	
	P49-80-M18-U-2m (516484)			0 .. 10 V	Fissa Fixed	
	P49-80-M18-I-2m (517651)			4 .. 20 mA		
	P49-50-M18-PNO-CM12 (516723)	60- 500 mm	1 x PNP, NO	Connettore M12 x 4 poli Connector M12 x 4 poles	Cavo Teach-In Cable Teach-In	
	P49-50-M18-U-CM12 (516696)		0 .. 10V		Fissa Fixed	
	P49-50-M18-I-CM12 (517210)		4 .. 20 mA			
	P49-50-M18-PNO-2m (517273)		Cavo 2m Cable 2m	1x PNP NO	Cavo Teach-In Cable Teach-In	
	P49-50-M18-U-2m (517277)			0 .. 10 V	Fissa Fixed	
	P49-50-M18-I-2m (517559)			4 .. 20 mA		
	P49-40-M18-PNO-CM12 (516664)	30- 400 mm	1 x PNP, NO	Connettore M12 x 4 poli Connector M12 x 4 poles	Cavo Teach-In Cable Teach-In	
	P49-40-M18-U-CM12 (516698)		0 .. 10V		Fissa Fixed	
	P49-40-M18-I-CM12 (517581)		4 .. 20 mA			
	P49-40-M18-PNO-2m (517274)		Cavo 2m Cable 2m	1x PNP NO	Cavo Teach-In Cable Teach-In	
P49-40-M18-U-2m (517278)	0 .. 10V			Fissa Fixed		
P49-40-M18-I-2m (517496)	4 .. 20 mA					

Serie P53

Custodia in acciaio inossidabile completamente incapsulata per utilizzo in condizioni ambientali gravose e applicazioni igieniche.

Con la serie P53 TESTA IN ACCIAIO l'offerta PIL si è ampliata con il primo sensore ad ultrasuoni con custodia completamente in acciaio inossidabile. Grazie alla speciale costruzione della custodia in acciaio inossidabile (1.4404) e una rugosità di soli 0,6µm, la TESTA IN ACCIAIO è perfetta per applicazioni in ambienti pesanti con presenza di polvere, umidità e vapore.

L'alto grado di protezione IP68 / IP69K permette una pulizia completa del sensore. Con una distanza di rilevamento fino a 1500mm e una resistenza a temperature elevate fino a +80°C è possibile utilizzare questi sensori per diverse applicazioni. Le versioni certificate EHEDG con custodia completamente liscia sono destinate all'industria alimentare e del packaging.

La regolazione avviene tramite cavo e connettore M12.

Series P53

Fully encapsulated stainless steel housing for use in harsh environmental conditions as well as in hygienic applications.

With the P53 STEEL HEAD series, PIL's product portfolio has been expanded to include the first ultrasonic sensor in a completely encapsulated stainless steel housing. Due to the special housing construction made of stainless steel (1.4404) with a roughness depth of 0.6µm the STEEL HEAD is well suited for use in harsh environments such as dust, moisture and water vapor.

The high degree of protection IP68 / IP69K enables a thorough cleaning of the sensor. With ranges of up to 1500 mm and the high temperature range up to + 80 °C opens up a wide range of applications. The EHEDG-certified versions with gap-free housing are predestined for use in the packaging and food industry.

The setting is made via the cable of the M12 connector. Optionally, switches are available.

Connettore M12 tensione di alimentazione, uscita del segnale, autoapprendimento

Connector M12 voltage supply, signal output, teach-in

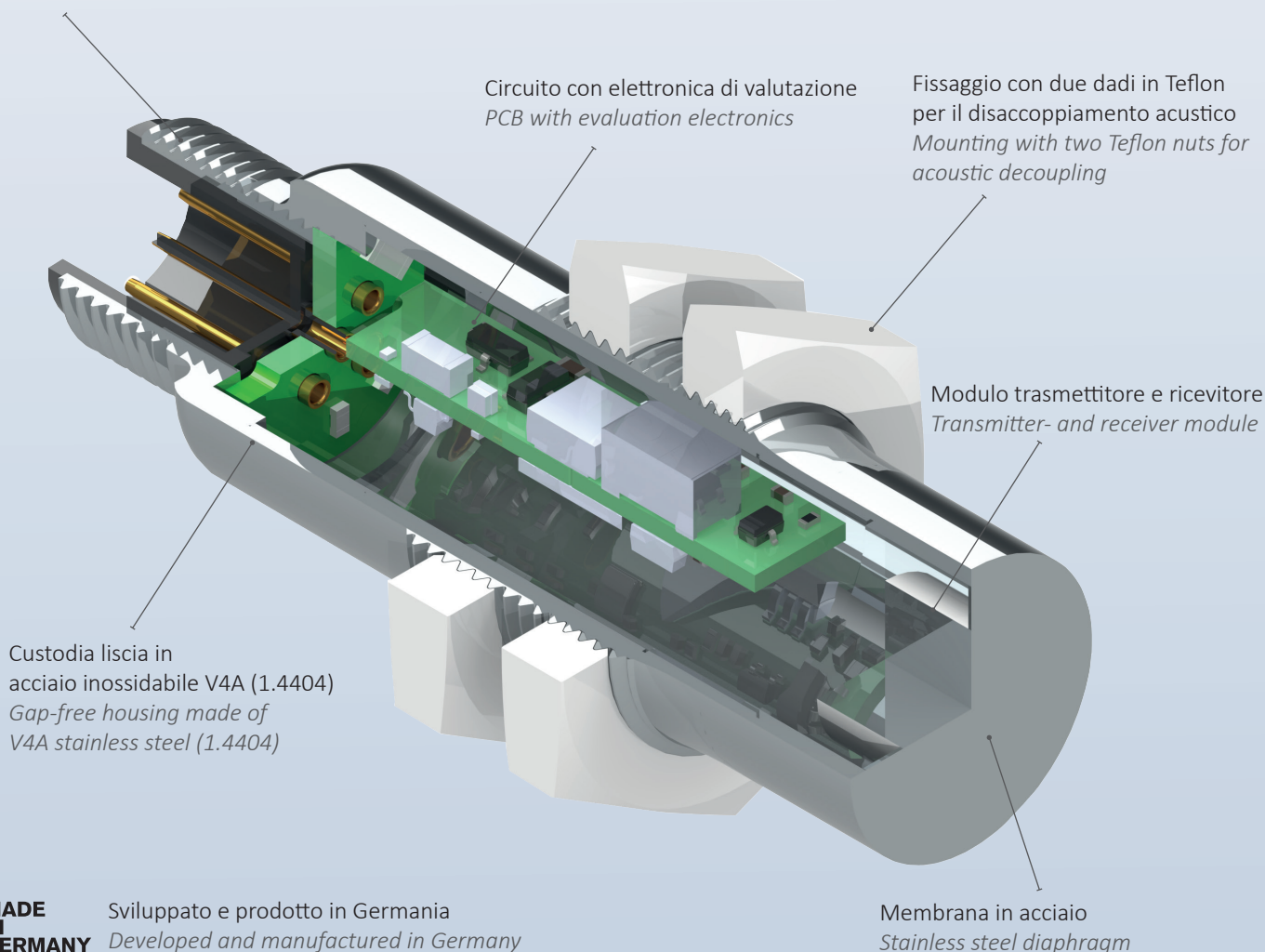

TESTA IN ACCIAIO adatta per applicazioni in ambienti gravosi

STEEL HEAD is well suited for use in harsh environments

P53	Tipo (articolo n.) Type (article no.)	Distanza di rilevamento Sensing Distance	Uscita Output	Connessione Connection	Regolazione Adjustment Setpoint	Custodia Housing
Serie P53 EHEDG / P53 EHEDG Series						
	P53-80-D18-2P-2m-EHEDG (517660)	120 .. 800 mm	2 x PNP	Cavo PVC 2m PVC Cable 2 m	Apprendimento via cavo Cable Teach-in	D18 V4A (1.4404)
	P53-80-D18-U-2m-EHEDG (517659)		0 .. 10V			
	P53-80-D18-I-2m-EHEDG (517658)		4 .. 20mA			
	P53-SC-D18-5-EHEDG	Avvitamento secondo l'approvazione EHEDG / Screwing EHEDG approved				
	P53-150-D30-PNO-2m-EHEDG	150 .. 1500 mm	1 x PNP, NO	Cavo PVC 2m PVC Cable 2 m	Apprendimento via cavo Cable Teach-in	D30 V4A (1.4404)
	P53-150-D30-PNC-2m-EHEDG		1 x PNP, NC			
	P53-150-D30-U-2m-EHEDG		0 .. 10V			
	P53-150-D30-I-2m-EHEDG		4 .. 20mA			
	P53-SC-D30-10-EHEDG	Avvitamento secondo l'approvazione EHEDG / Screwing EHEDG approved				
Serie P53 Industriale / P53 Industrial Series						
	P53-80-D18-2P-CM12 (517657)	120 .. 800 mm	2 x PNP			D18 V4A (1.4404)
	P53-80-D18-U-CM12 (517656)		0 .. 10V			
	P53-80-D18-I-CM12 (517655)		4 .. 20mA			
	P53-150-D30-PNO-CM12 (517078)	150 .. 1500 mm	1 x PNP, NO	Connettore Binder M12 x 5p Binder Connector M12 x 5p	Apprendimento via cavo Cable Teach-in	D30 V4A (1.4404)
	P53-150-D30-PNC-CM12 (517119)		1 x PNP, NC			
	P53-150-D30-U-CM12 (517060)		0 .. 10V			
	P53-150-D30-I-CM12 (517117)		4 .. 20 mA			
	P53-150-M30-PNO-CM12 (517079)	150 .. 1500 mm	1 x PNP, NO			M30 V4A (1.4404)
	P53-150-M30-PNC-CM12 (517120)		1 x PNP, NC			
	P53-150-M30-U-CM12 (517061)		0 .. 10V			
	P53-150-M30-I-CM12 (517118)		4 .. 20 mA			

Il sensore e la sua staffa di montaggio sono costruiti in modo tale da essere adatti nelle applicazioni per ambienti gravosi e soddisfano i più elevati requisiti di igiene nell'industria alimentare (Classe I Aux).

The sensor and its mounting are constructed in terms of materials, geometry and surface qualities so that they are suitable for use in harsh environments and for the highest hygiene requirements in the food industry (Class I Aux).

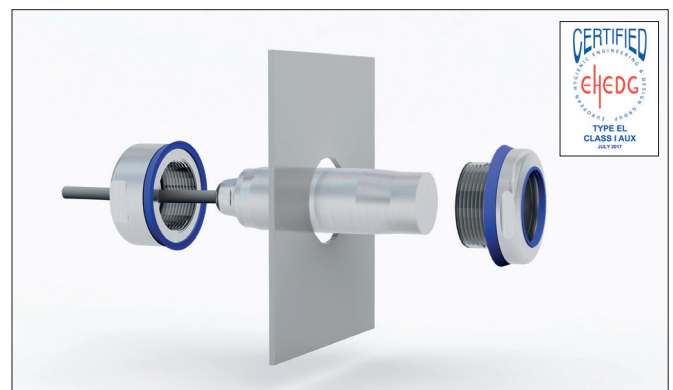

sensor**matic**

SPECIALIST&SOLUTIONS

