

# CLS-23

# Dinel<sup>®</sup>

## CAPACITIVE LEVEL SENSORS

Miniature capacitive level sensor for sensing various types of liquids



### TECHNICAL SPECIFICATIONS

Supply voltage	6 ... 30 V DC	
Supply current	output type P output type S	max. 0,6 / 7 mA (OFF / ON state) max. 0,6 mA (OFF state)
Switched current	output type P output type S	max. 100 mA 3,3 mA / 40 mA (min. / max.)
Voltage drop in the closed state	output type P output type S	1,8 V 6,0 V
Output time delay	0,1 s	
Protection class	IP68 (0,1 MPa)	
Safety integrity level	SIL 1	
Cable (for cable outlet performance)	CLS-23 CLS-23E	PVC 2x 0,34 mm <sup>2</sup> (3x 0,34 mm <sup>2</sup> ) silicone 2x 0,5 mm <sup>2</sup>
Weight (with 2 m cable and 30 mm electrode)	CLS-23 N, E, Xi CLS-23 NT, XiT	aprox. 45 g aprox. 190 g
Output type	S / PNP NAMUR	N, E, NT, Xi, XiT
Process connection	M18 x 1,5, M20 x 1,5 G3/8", G1/2", NPT 1/2 - 14	

- For level detection of electrically conductive and non-conductive liquids
- Compact miniature performance for direct mounting to vessels, tanks, sumps and tubes
- Easy setting by means of magnetic pen
- SIL 1 according the standard EN 61508
- High temperature performance available
- Outputs S, PNP, NAMUR
- LED state indication \*

\* Variant „E“ without LED state indicator

# BASIC FEATURES AND VARIANTS

**Capacitive level sensors (switches) CLS-23** are designed for limit level detection of electrically conductive and non-conductive liquids in vessels, reservoirs, sumps, pipes, tanks, etc. The sensitivity of the sensor can be easily set by placing magnetic pen on sensitive spot.

The process coupling at the housing can be with metric thread (M18x1.5 ; M20x1.5), pipe thread (G3/8" ; G1/2") or sealing thread (NPT 1/2-14). Output performances – transistor output with open collector (PNP), two wire electronic switch (S) and NAMUR output for intrinsically safe connection.

There are next performances available:

- N** – Normal for non-explosive areas,
- E** – Extended temperature range for non-explosives areas,
- Xi** – Explosion proof (intrinsically safe for explosive areas),
- NT** – High temperature variant for non-explosives areas
- XiT** – High temperature variant for explosive areas.

CLS-23 capacitive level sensors meet the safety integrity level requirements according to standard EN 61508 at level SIL 1.

## VARIANTS

code	type	electrode length
CLS-23-10	Uncoated short bar electrode	30 mm
CLS-23-11	Fully coated short bar electrode	30 mm
CLS-23-12	Fully coated short bar electrode	30 mm
CLS-23-20	Partially coated rod electrode	50 mm ... 1 m
CLS-23-21	Fully coated rod electrode	50 mm ... 1 m
CLS-23-30	Dismountable uncoated rod electrode	50 mm ... 1 m

## DIMENSIONS

CLS-23\_-10

CLS-23\_-11(12)

CLS-23\_-20

CLS-23\_-21

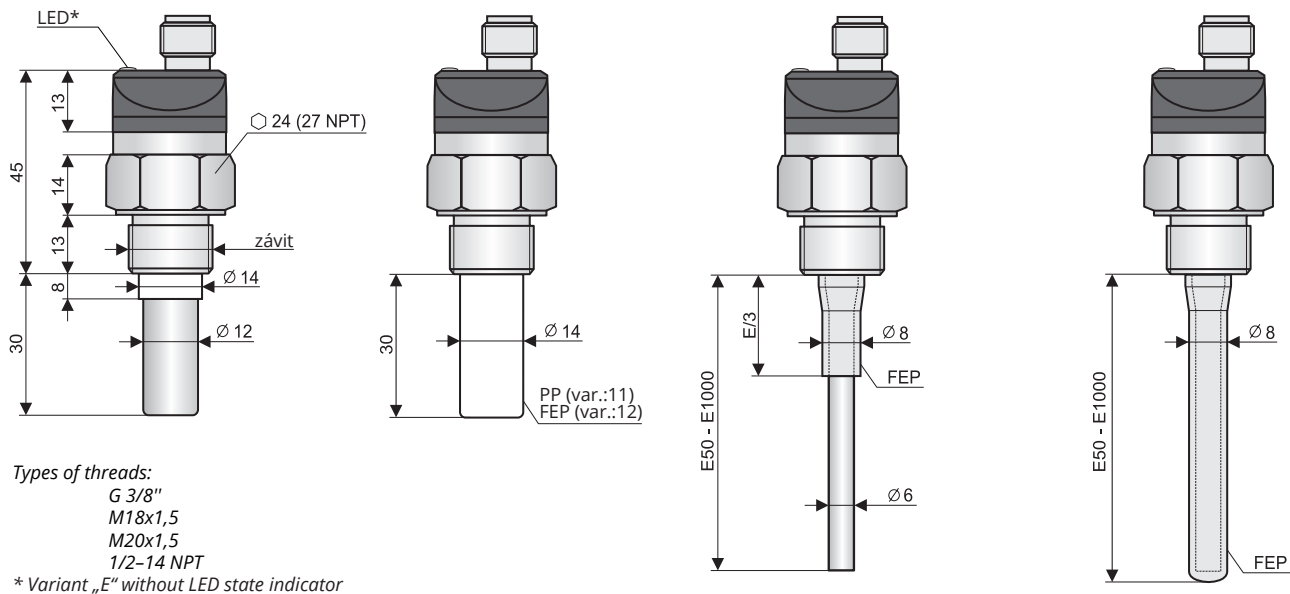

For more information, please refer to the CLS-23 manual on our website [www.dinel.cz](http://www.dinel.cz)

CLS-23\_-30

High temperature variant  
(CLS-23\_T-10;12;20;21;30)

Variant „C” with connector  
(except CLS-23E)

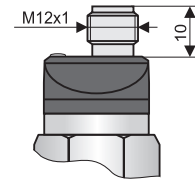
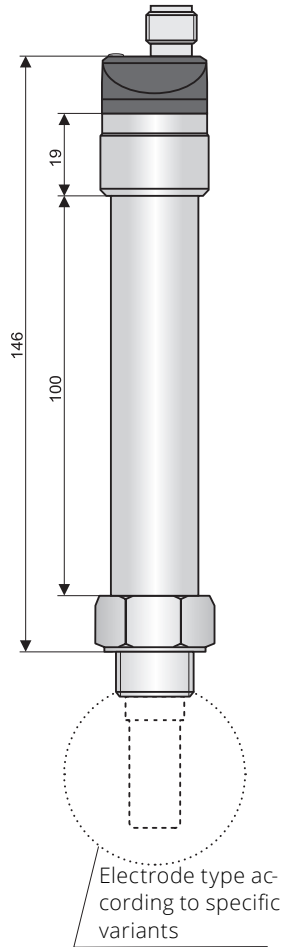
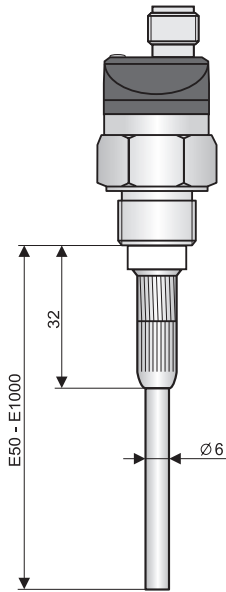

Variant „A”  
with cable outlet

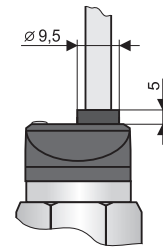

# TECHNICAL SPECIFICATIONS

## ELECTRICAL PARAMETERS - variants Xi, XiT

Supply voltage	8 ... 9 V DC
Current supply (state OFF / ON) - NAMUR	≤ 1 mA / ≥ 2,2 mA
Max. internal values	$U_i = 12 \text{ V DC}$ ; $I_i = 15 \text{ mA}$ ; $P_i = 45 \text{ mW}$ ; $C_i = 15 \text{ nF}$ ; $L_i = 10 \text{ } \mu\text{H}$
Coupling capacity / Electric strength	44 nF / 250 V AC
Reference value of LC parameters of used cable	Typical C < 150 pF/m Typical L < 0,8 $\mu\text{H}$ /m

## MATERIAL PERFORMANCE

Sensor part	Variants	Material
Housing	All variants	Plastic PP
Process coupling	All variants	Stainless steel W.Nr. 1.4305 (AISI 303)
Electrode	All variants	Stainless steel W.Nr. 1.4305 (AISI 303)
Electrode insulation	CLS-23_11	Plastic PP
Electrode insulation	CLS-23_12, 20, 21	Plastic FEP

## WORKING AREAS AND AREA CLASSIFICATION (EN 60079-10-1)

CLS - 23N	Basic performance for non-explosive areas.
CLS - 23E	Extended temperature performance for non-explosive areas.
CLS - 23NT	High-temperature basic performance for non-explosive areas.
CLS - 23Xi (XiT)-10 CLS-23Xi (XiT)-30	Intrinsically safe explosion-proof (XiT - high-temperature) performance for use in hazardous areas (explosive gas atmospheres $\text{II 1/2 G Ex ia IIC T6 ... T3 Ga/Gb}$ with intrinsically safe supply units, electrode part zone 0, head zone 1.
CLS - 23Xi-11, 12, 20, 21	Intrinsically safe explosion-proof performance for use in hazardous areas (explosive gas atmospheres $\text{II 1 G Ex ia IIB T6 ... T3 Ga}$ with intrinsically safe supply units, whole sensor zone 0.
CLS - 23XiT-12, 20, 21	Intrinsically safe high-temperature explosion-proof performance for use in hazardous areas (explosive gas atmospheres $\text{II 1/2 G Ex ia IIB T6 ... T3 Ga/Gb}$ with intrinsically safe supply units, electrode part zone 0, head zone 1.

## TEMPERATURE AND PRESSURE RESISTANCE - variants Xi, XiT

Variant (Performance)	Temperature tp	Temperature tm	Temperature ta	Max. operating pressure for temperature tp				
				to 30°C	to 85°C	to 105°C	to 130°C	to 150°C
CLS-23Xi-10	-25°C ... +105°C	-25°C ... +105°C	-20°C ... +75°C	8 MPa	6 MPa	5 MPa	-	-
CLS-23XiT-10	-30°C ... +150°C	-30°C ... +150°C	-20°C ... +75°C	8 MPa	6 MPa	5 MPa	4 MPa	3 MPa
CLS-23Xi-11	-10°C ... +105°C	-10°C ... +105°C	-10°C ... +75°C	7 MPa	5 MPa	4 MPa	-	-
CLS-23Xi-12	-25°C ... +105°C	-25°C ... +105°C	-20°C ... +75°C	8 MPa	6 MPa	5 MPa	-	-
CLS-23XiT-12	-30°C ... +150°C	-30°C ... +150°C	-20°C ... +75°C	8 MPa	6 MPa	5 MPa	4 MPa	3 MPa
CLS-23Xi-20	-25°C ... +105°C	-30°C ... +150°C *	-20°C ... +75°C	3 MPa	2,5 MPa	2 MPa	-	-
CLS-23XiT-20	-30°C ... +150°C	-30°C ... +150°C	-20°C ... +75°C	3 MPa	2,5 MPa	2 MPa	1,5 MPa	1 MPa
CLS-23Xi-21	-25°C ... +105°C	-30°C ... +150°C *	-20°C ... +75°C	3 MPa	2,5 MPa	2 MPa	-	-
CLS-23XiT-21	-30°C ... +150°C	-30°C ... +150°C	-20°C ... +75°C	3 MPa	2,5 MPa	2 MPa	1,5 MPa	1 MPa
CLS-23Xi-30	-25°C ... +105°C	-30°C ... +150°C *	-20°C ... +75°C	8 MPa	6 MPa	5 MPa	-	-
CLS-23XiT-30	-30°C ... +150°C	-30°C ... +150°C	-20°C ... +75°C	8 MPa	6 MPa	5 MPa	4 MPa	3 MPa

\* Valid for top mounting (in vertical position)

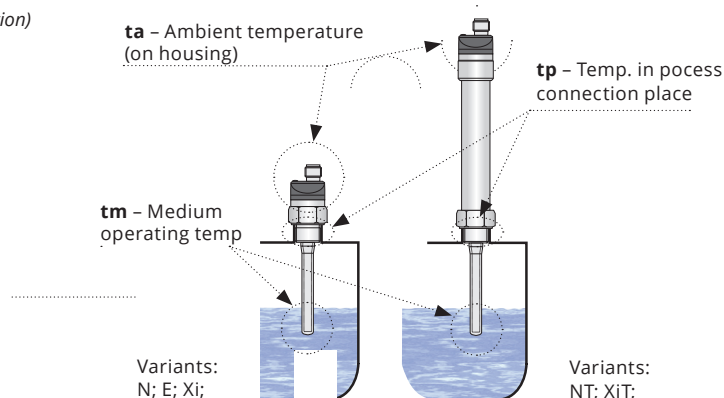

## TEMPERATURE AND PRESSURE RESISTANCE - variants N, E, NT

Variant (Performance)	Temperature tp	Temperature tm	Temperature ta	Max. operating pressure for temperature tp				
				to 30°C	to 85°C	to 105°C	to 130°C	to 150°C
CLS-23N-10	-25°C ... +105°C	-25°C ... +105°C	-20°C ... +80°C	8 MPa	6 MPa	5 MPa	-	-
CLS-23E-10	-25°C ... +120°C	-25°C ... +120°C	-25°C ... +105°C	8 MPa	6 MPa	5 MPa	-	-
CLS-23NT-10	-30°C ... +150°C	-30°C ... +150°C	-20°C ... +80°C	8 MPa	6 MPa	5 MPa	4 MPa	3 MPa
CLS-23N-11	-10°C ... +105°C	-10°C ... +105°C	-10°C ... +80°C	7 MPa	5 MPa	4 MPa	-	-
CLS-23E-11	-10°C ... +105°C	-10°C ... +105°C	-10°C ... +105°C	7 MPa	5 MPa	4 MPa	-	-
CLS-23N-12	-25°C ... +105°C	-25°C ... +105°C	-20°C ... +80°C	8 MPa	6 MPa	5 MPa	-	-
CLS-23E-12	-25°C ... +120°C	-25°C ... +120°C	-25°C ... +105°C	8 MPa	6 MPa	5 MPa	-	-
CLS-23NT-12	-30°C ... +150°C	-30°C ... +150°C	-20°C ... +80°C	8 MPa	6 MPa	5 MPa	4 MPa	3 MPa
CLS-23N-20	-25°C ... +105°C	-30°C ... +150°C *	-20°C ... +80°C	3 MPa	2,5 MPa	2 MPa	-	-
CLS-23E-20	-25°C ... +120°C	-30°C ... +150°C *	-25°C ... +105°C	3 MPa	2,5 MPa	2 MPa	-	-
CLS-23NT-20	-30°C ... +150°C	-30°C ... +150°C	-20°C ... +80°C	3 MPa	2,5 MPa	2 MPa	1,5 MPa	1 MPa
CLS-23N-21	-25°C ... +105°C	-30°C ... +150°C *	-20°C ... +80°C	3 MPa	2,5 MPa	2 MPa	-	-
CLS-23E-21	-25°C ... +120°C	-30°C ... +150°C *	-25°C ... +105°C	3 MPa	2,5 MPa	2 MPa	-	-
CLS-23NT-21	-30°C ... +150°C	-30°C ... +150°C	-20°C ... +80°C	3 MPa	2,5 MPa	2 MPa	1,5 MPa	1 MPa
CLS-23N-30	-25°C ... +105°C	-30°C ... +150°C *	-20°C ... +80°C	8 MPa	6 MPa	5 MPa	-	-
CLS-23E-30	-25°C ... +120°C	-30°C ... +150°C *	-25°C ... +105°C	8 MPa	6 MPa	5 MPa	-	-
CLS-23NT-30	-30°C ... +150°C	-30°C ... +150°C	-20°C ... +80°C	8 MPa	6 MPa	5 MPa	4 MPa	3 MPa

\* Valid for top mounting (in vertical position)

## ELECTRICAL CONNECTION

For "A" variant with the fixed cable, the individual color cores of the connecting cable are connected to the respective terminals of the related equipment (supply unit).

For "C" variant with the connector, the cable can be supplied with the sensor (length 2 or 5 m), fitted with the pressed connector socket or dismountable connector socket without the cable (see accessories), the connector is not part of the sensor. In this case the cable is connected to the inside pins of the socket according to Fig.

The sensor with related equipment is interconnected by a suitable three-core (P variation) or two-core (S and R variations) cable. The length of the cable for the Xi and XiT variations must be selected with respect to the maximum permitted parameters (usually inductance and capacity) of the outside intrinsically safe circuit of supply units (NSSU, NDSU, NLCU). If using a dismountable connector socket, the outside diameter of the cable is a maximum of 6 mm

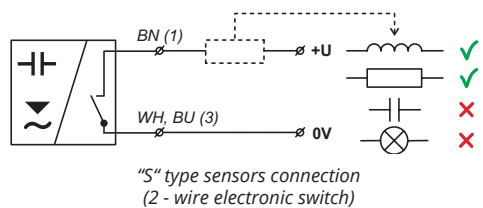

### Type CLS-23-\_-\_-S-

The positive power terminal +U is connected via a load (e.g. a relay) to the brown wire, or connector pin no.1, the negative terminal to the white wire (configuration "N" and "NT") or to the blue wire (configuration "E") or to connector pin No.3.

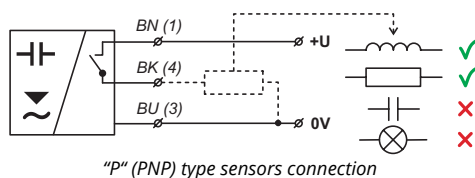

### Type CLS-23-\_-\_-P-

Positive pole (+ U) of power supply is connected to brown wire or pin connector No. 1, negative pole is connected to blue wire or pin connector No. 3. Load (relay) is connected to black wire or pin connector No. 4.

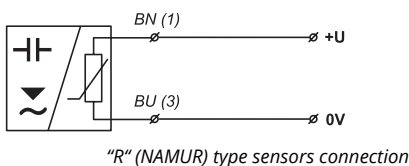

### Type CLS-23-\_-\_-R-

Brown wire or pin connector No. 1 is connected to positive pole (+U) of Intrinsically safe supply unit. Blue wire or pin. connector No.3 is connected to negative pole of Intrinsically safe supply unit.

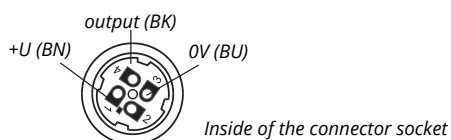

### Legend:

(1...4) - terminals number for variants with connector

**BN** - brown  
**WH** - white  
**BK** - black  
**BU** - blue

# SETTING

The settings are done by touching a magnetic pen MP - 8 on the sensitive spot (M) located on the front-side of the sensor. By touching with the magnetic pen for a short time (max. 2 sec) on the sensitive spot (M), the sensor will open, holding down the magnetic pen for longer (min. 4 sec) the sensor will close. In this way, the sensitivity to the measured medium and the switching modes (O, C) are set.

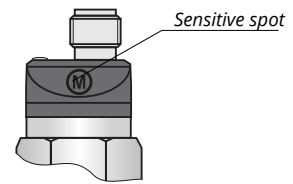

**mode O** (switches when submerged) On an empty or partially filled tank (level below the bottom edge of the sensor), touch the sensitive area (M) for 1 sec with the magnetic pen (the sensor will open). When the tank fills up above the top edge of the sensor, touch the sensitive area (M) for 5 sec. with the magnetic pen (the sensor will close).

**mode C** (unswitches when submerged) On an empty or partially filled tank (level below the bottom edge of the sensor), touch the sensitive area (M) for 5 sec with the magnetic pen (the sensor will close). When the tank fills up above the top edge of the sensor, touch the sensitive area (M) for 1 sec. with the magnetic pen (the sensor will open).

On installations from above, it is necessary during detection of **non-conductive** liquids using sensors **CLS-23\_-20; -30** and during detection of **conductive** and **non-conductive** liquids using sensor **CLS-23\_-21** to set the limits for closing and opening with the electrode submerged in the medium.

The closing and opening limits are shifted closer to the state with a submerged electrode.

The CLS-23E range of sensors is made without a signal LED indicator. To check the correctness of settings, it is necessary to connect a connected device or a load and to use it to receive information about the opened / closed status of the sensor.

**CLS-23\_-10, -20, -30** sensors; are factory set to detect mineral oil, **CLS - 23\_- 11; -12; -21** for drinking water detection. The switching is set to the „O“ mode (the sensor switches on when flooded).

# FUNCTION AND STATUS INDICATION (ONLY WITH LED STATE INDICATOR VARIANT)

In the following table are the types of inputs and the respective statuses (ON/ OFF) in the case of a maximum and minimum level sensing. The signalling of the status of the sensor is indicated by the orange LED located on the upper area of the sensor beside the connector (cable).

Indicator	Function
<b>Orange LED</b>	<b>Continuous light</b> - Sensor is closed (switched ON)
	<b>Dark</b> - Sensor is open (switched OFF)
	<b>Rapid flashing (period 0.2 s)</b> - error setting *
	<b>Slow flashing (period 0.8 s)</b> - short circuit at sensor output

\* Limit setting for closing (opening) on the same level or impossibility of differentiate between closing level and opening level (low permittivity of the medium).

Level state	Mode	Type of sensor	Output state	LED indicator *
Minimum level sensing	O	CLS-23_-_-_-_-P_- CLS-23_-_-_-_-S_-	CLOSED	(Shine)
		CLS-23Xi_-_-_-R_- CLS-23XiT_-_-_-R_-	LOWER CURRENT	
	O	CLS-23_-_-_-_-P_- CLS-23_-_-_-_-S_-	CLOSED	(Dark)
		CLS-23Xi_-_-_-R_- CLS-23XiT_-_-_-R_-	LOWER CURRENT	
Maximum level sensing	C	CLS-23_-_-_-_-P_- CLS-23_-_-_-_-S_-	CLOSED	(Shine)
		CLS-23Xi_-_-_-R_- CLS-23XiT_-_-_-R_-	LOWER CURRENT	
	C	CLS-23_-_-_-_-P_- CLS-23_-_-_-_-S_-	CLOSED	(Dark)
		CLS-23Xi_-_-_-R_- CLS-23XiT_-_-_-R_-	LOWER CURRENT	

Sensor with type output „S“ and „R“ for each flash of the LED switches its output on for approx. 3 ms. This period is sufficiently short to avoid unwanted switching of relay contacts. For binary inputs, we recommend to set the filter so as not to respond to pulses shorter than 3 ms.

Units Dinel NSSU, NDSU a NLCU with transistor switch („T“) detects and transmits these pulses to the output.

For security reasons, we recommend to set the mode O (normally open, sensor closes when immersed) for minimum level detection. Any failure of the sensor or wiring is equally apparent as the emergency level state. Analogously - for the maximum level detection is recommended to set the mode C (normally closed, sensor opens when immersed).

\* Variant „E“ without LED state indicator

# ORDER CODE AND CORRECT SPECIFICATION EXAMPLE

## ORDER CODE

CLS-23

### PERFORMANCE

- N** normal for non-explosive areas
- E** extended temperature range variants for nonexplosive areas (without LED)
- NT** high temperature variants for non-explosive areas
- Xi** (intrinsically safe) for hazardous areas
- XiT** (intrinsically safe) high temperature variants

### TYPE AND ELECTRODE PERFORMANCE

- 10** Uncoted bar 30mm
- 11** Coated (PP) bar 30mm (only for N and Xi)
- 12** Coated (FEP) bar 30 mm
- 20** Partly coated (FEP) rod, 50 ... 1000 mm
- 21** Fully insulated (FEP) rod, 50 ... 1000 mm
- 30** Uncoated removable rod, 50 ... 1000 mm

### ELECTRIC CONNECTION

- A** cable outlet (+ cable length)
- C** connector - except variant „E“  
(socket not included with sensor, recommended type - see accessories.)

### OUTPUT TYPE

- P** PNP (Open collector)
- S** 2-wire electronic switch
- R** NAMUR (Changing the supply current)

### PROCESS CONNECTION

- G3/8** pipe thread G 3/8"
- G1/2** pipe thread G 1/2"
- M18** metric thread M 18x1,5
- M20** metric thread M 20x1,5
- NPT** sealing thread NPT 1/2-14

### LENGTH OF ELECTRODE IN MM

- E** length of electrode in mm
- E30** for electrode type 10,11,12

### LENGTH OF CABLE IN M

- K** length of cable in m (only for A)

CLS-23 N - 10 - A - S - NPT - E30 12 EXAMPLE OF CODING

# SAFETY, PROTECTION, COMPATIBILITY AND EXPLOSION PROOF

The level sensor is equipped with protection against electric shock on the electrode, reverse polarity, output current overload, short circuit and against current overload on output.

Protection against dangerous contact is provided by low safety voltage according to 33 2000-4-41. Electromagnetic compatibility is provided by conformity with standards EN 55011 / B, EN 61326-1, EN 61000-4-2 (8 kV), -4-3 (10 V/m), -4-4 (2 kV), -4-5 (1 kV) and -4-6 (10 V).

Explosion proof CLS-23Xi and XiT is provided by conformity with standards EN 60079-0:2013+A11:2014, EN 60079-0:2012.

Explosion proof CLS-23Xi and XiT is verified FTZÚ – AO 210 Ostrava – Radvanice: FTZÚ 12 ATEX 0106X.

A declaration of conformity was issued for this device in the wording of Act No. 90/2016 Coll., as amended. Supplied electrical equipment matches the requirements of valid European directives for safety and electromagnetic compatibility.

Special conditions for safe use of variant CLS-23Xi (XiT)

If the apparatus is used as device of Group II and with using of an approved power supply device, which output parameters comply with required input parameters, it is necessary to have an galvanic separation or in case of apparatus without galvanic separation (Zener barriers) it is necessary to provide equipotential equalizing between sensor and barrier earthing point.

Design CLS-23Xi-11 (12, 20, 21) can be used in zone 0. Other design DLS-23Xi can be used in zone 0 only electrode part and head with electronics can be used only in zone 1.

Ambient temperature:  $T_{amb} = -20^{\circ}\text{C} \dots +75^{\circ}\text{C}$

Temperature of measured medium according to design variant:



Xi type 10, 12:  $(-25^{\circ}\text{C} \text{ to } +105^{\circ}\text{C})$

Xi type 11:  $(-10^{\circ}\text{C} \text{ to } +105^{\circ}\text{C})$

Xi type 20, 21, 30, XiT:  $(-30^{\circ}\text{C} \text{ to } +150^{\circ}\text{C})$

Maximum temperature of electrodes is equal to temperature of measured medium.

## ACCESSORIES

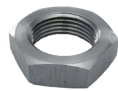
1 pcs magnetic pen	included in the price	MP-8	
1 pcs. seal (asbestos free)	included in the price	Klingerit	
cable (over the standard length 2m)	at extra cost		
non-detachable connector M12 (variants N, NT) with cable length 2 or 5m	at extra cost		
detachable connector M12 with outlet PG7 (variants N, NT)	at extra cost		
steel (ON) or stainless steel (NN) welding flange	at extra cost		
stainless steel fixing nut UM-18x1,5	at extra cost		
various types of seals (PTFE, AI, etc.)	at extra cost		

**SENSORMATIC**  
SPECIALIST SOLUTIONS

Sensormatic srl - Via della Beverara 13 - 40131 Bologna - Italia  
Tel. +39 051 6353 511 - www.sensormatic.it

*The manufacturer reserves the right to change the specifications and appearance of the product without prior notice.*

**Dinel, s.r.o.**  
U Tescomy 249, 760 01 Zlín  
tel.: +420 577 002 000  
e-mail: sale@dinel.cz

[www.dinel.cz](http://www.dinel.cz)

version:  
01/2024

